

# VICTORIA™

Design Floors

## Fitting Instructions

*Click*

**Distinctive™**  
FLOORING

**Universal**  
DESIGN FLOORING

Issue: October 2022

# VICTORIA™

## Design Floors

### Suitability of use

**Residential:** Kitchens, Bathrooms, Hallways, Living Rooms, Dining Rooms, Studies and Bedrooms.

It is possible to install into conservatories and south facing rooms but it is essential that the room is protected from direct sunlight to limit solar gain. The room must be kept at a maintained climate where the floor temperature will not exceed 27 degrees. If installing into one of these locations, ensure that all direct sunlight is blocked out so that the room does not exceed the recommended fitting temperatures.

**Kitchen Installation** - Kitchen units and any items of a significant weight (American Fridges for example) should be fitted directly on top of the subfloor. **Under no circumstances should fixed items be installed on top of a click floating floor.** Ensure that an expansion gap is used on any fixed items.

**Light Commercial:** Suitable for most areas except those subjected to high traffic, heavy rolling loads or locations with wide temperature variations.



### Storage

Make sure that the flooring is always stored on a flat surface and should never be stored upright. If the material is not stored flat, you could find that you encounter problems when fitting the floor.

When opening the packaging, **DO NOT** open and empty out from one end as this can cause the click mechanisms to break.

### Acclimatisation - Product and Room

To give the flooring enough time to relax, we recommend that the product is stacked in small piles in the installation location at least 24 hours before fitting. The ideal fitting temperature is approximately 18 - 25°C.

The room in which the flooring will be installed should also be acclimatised for approx. 48 hours prior and for at least 24 hours after completion at a steady temperature of between 18 - 27°C.

The minimum subfloor temperature should be 15°C.

Underfloor heating should be turned off 48 hours prior to laying a floor covering.

# VICTORIA™

## Design Floors

### Sub-floor Preparation

Make sure that the floor is sound, smooth, clean and dry. If not, you will need to carry out the appropriate preparation work before installation to BS8203.

- **New Concrete/Sand Cement Screeds:**

If a new concrete floor has a reading of below 75% relative humidity (RH) prime the floor and apply a compatible smoothing compound to a minimum of 3mm. For readings above 75% RH floors consult your supplier for information relating to surface damp proof membrane (DPM) requirements.

- **Old/Refurbished Concrete/Sand Cement Screeds:**

For readings below 75% RH, the floor covering, and adhesive residue must be removed, and the surface primed before applying a compatible smoothing compound to a minimum of 3mm.

For readings above 75% RH consult your supplier for information relating to surface DPM requirements.

- **Power Floating Concrete:**

If readings with the hygrometer are below 75% RH the power floated floors require abrasion prior to the application of a primer and compatible smoothing compound to a minimum of 3mm. (Abrasion can be either scarification or light shot blasting). For readings above 75% RH the surface still require abrasion before applying a surface DPM.

- **Mosaics/Ceramics/Quarry Tiles:**

Level any grout lines with a depth of >2mm and/or a width of >5mm with a smoothing compound or screed filler to make the floor solid.

- **Timber Floors**

All boards must be firmly fastened, and any gaps filled. Ensure that there is no damp or mould. Should any be visible, these planks will need replacing. Loose boards will require fixing and any difference in levels on planks will also need addressing. In the case of any unevenness of wooden floor, it is also recommended to install smoothing boards. We recommend you do not install over solid hardwood floors without seeking advice from one of our retail partners.

- **Linoleum/Thermoplastic/Vinyl/Cork Floors:**

Ensure the floor is solid; fix any loose tiles.

- **Metal and Painted Floors:**

Remove any loose paint or other finishes.

Note: Additional underlay must not be used with any of Victoria Design Floors click products that already feature a built-in underlay.

# VICTORIA™

## Design Floors

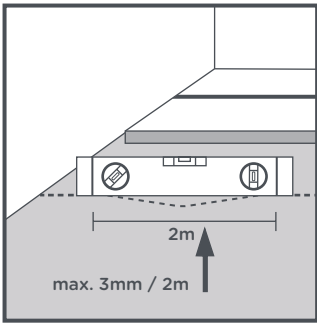

Before installation, the surface should be checked for evenness using a 2m long straight edge / spirit level.

Any unevenness observed cannot exceed 3mm. Any unevenness exceeding 3mm over a length of more than 2m must be smoothed with subfloor preparations carried out in line with BS8203 guidelines.

### **Underfloor heating**

Make sure that the underfloor heating has been switched off for at least 48 hours prior to fitting.

Wait at least 24 hours after fitting the flooring before turning back on and increase the temperature of room by no more than 5 °C per day up to a maximum subfloor temperature of 27°. The temperature of the floor should never exceed 27 degrees as this will cause your floor to fail.

### **Avoid colour differences**

We recommend that you use material from only one batch within each room. To check these, please refer to the product stickers on the packaging.

To achieve the most realistic result, we advise that packs are always mixed together to ensure an even distribution of design and colour.

# VICTORIA™

## Design Floors

### Fitting

Victoria Design Floors SPC Click should be installed using the below expansion gap guidelines.

Wall Length	Expansion Gap
1m - 5m	5mm
6m	6mm
7m	7mm
8m - 10m	8mm

This gap can then be covered by either the skirting board, low modulus silicon, finishing strip or beading.

Where the flooring run exceeds 10 linear metres (25ft) in width or length, insert a 10mm (0.2") expansion joint, then repeat every 10 metres (25ft) thereafter.

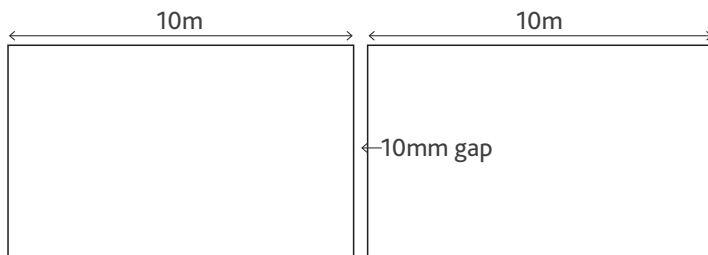

Allow a gap of 15-20mm around pipes.

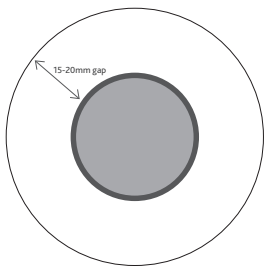

Skirting boards may be removed and door frames undercut to allow for expansion. Please ensure you allow for an expansion gap at all door ways/door check.

# VICTORIA™

## Design Floors

### Installation Plan

To achieve the best layout and the least waste possible we advise you prepare a working drawing before you start to fit the floor.

Plank products should be installed with staggered joints, at a distance of at least 200mm (8”).

Tiled products should be installed broken bond to give the floor maximum stability and enhance the aesthetics of the floor.

### Tools

For a successful installation the following tools will be necessary:

- Rubber mallet
- 2m straight edge or spirit level
- Wall spacers
- Carpenters square
- Pencil
- Ruler
- Measuring tape
- Sharp utility knife
- Tapping block

### Optional Tools

- Guillotine
- Kneepads
- Multi-tool
- Slide hammer

# VICTORIA™

## Design Floors

### Fitting Instructions: Setting Up

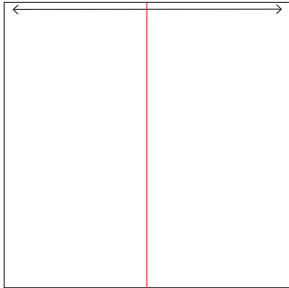

To achieve the best layout and the least waste possible we advise you prepare a working drawing before you start to fit the floor.

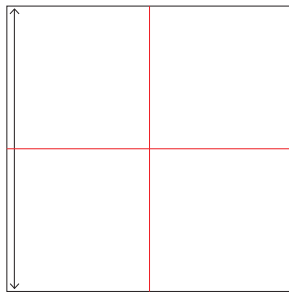

Start by marking the centre of the room, both horizontally and vertically. You will want to physically draw a line on your sub-floor as you will need to refer to this to get started.

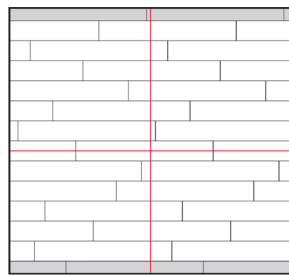

First row

Last row

To ensure your floor is uniform in appearance, you will need to make sure that your first and last rows are the same size.

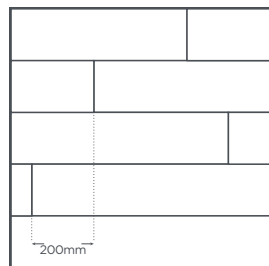

### Wood

Should be fitted with random staggered joints with a minimum of 200mm between short ends

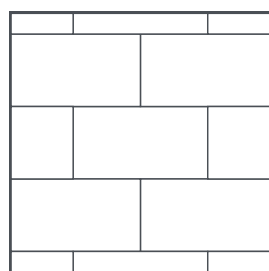

Brick Bond

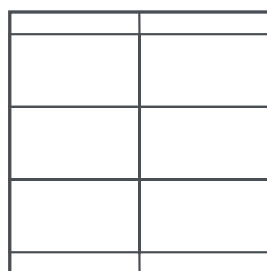

Uniform

### Stone

Should be fitted in a brick bond design or uniform

# VICTORIA™

## Design Floors

### Fitting Instructions

1. Install the first plank or tile with the tongue side facing the longest wall, fit spacers (5-8mm\*) between the plank and the wall.
2. Lay the first row, ensuring the short edges are clicked together. Following the diagrams above, be sure to stagger joints to achieve a professional installation.
3. When cut the last piece of the row remember to leave your expansion gap of 2-8mm between the end of the row and the wall.
4. Begin the second row by clicking the tongue into the groove holding the tile or plank at an angle (approximately 30°). Then push the tile or plank firmly into the groove of the first row.
5. For the next tile or plank click the tongue and groove together along the shortedge. Ease the tongue and groove together on the long side by angling the tiles/planks together.
6. Continue to fit the tiles/planks across the room until the row is complete. We recommend using a rubber mallet and an off-cut of the product or a hand roller to securely fix the tiles/planks together. Ensure the click is not hammered directly with force. Repeat until the installation is complete.
7. Once the floor is completed, remove the spacers. Fix skirting boards or a suitable edge trim to cover the expansion gaps making sure that you do not pinch the floor. These should be fixed to the wall and not the floor. Alternatively, you could use a large silicone joint.

\*Remember this is for spaces of under 10 linear meters. If over 10 l/m this should increase to 10mm per 10 meters.



# VICTORIA™

## Design Floors

### After Installation

- Ensure your floor is clear of debris.
- When it is time to move your furniture back in place; lift, don't drag.
- Apply felt pads to furniture legs and feet to help protect the floor and for larger items consider castor cups.
- If moving really heavy items back into place (washing machines/fridge freezers etc) protect the floor with sheets of strong cardboard or heavy fabrics.

### Protecting your floor

By following the below hints and tips, your LVT floor will continue to look as good as the day it was installed.

- Use felt pads to protect chair legs.
- Lift furniture rather than dragging as this can cause damage to your floor.
- When moving heavy items of furniture or household appliances protect the floor with sheets of cardboard or thin pieces of hardboard.
- To protect the floor from indentations, use castor cups to help distribute the weight.
- Use non-rubber backed entrance mats to prevent any discolouration of the floor and protect for dirt being walked into the house.
- Maintain room temperature between 13-27°C (55-81°F) for optimum performance.

The Company reserves the right to amend fitting instructions at any time in response to new/improved techniques and/or revised industry fitting advice issued by the BSI.

For the most up to date instructions please refer to the technical section on the [MyVictoria.co.uk](http://MyVictoria.co.uk) website.